

TL4

series



Product Segments

• Ergo Motion

TiMOTION's TL4 series lifting columns are specifically designed for use in ergonomic desks and work tables. Using multiple TL series lifting columns with compatible TC series Control Boxes and TH / TDH series controls, work surfaces can be controlled quietly and smoothly with synchronous movement. All Ergo Motion TC series control boxes have a less than 0.1W standby power option that reduces power consumption. Our wide range of columns offer customers the solutions they require to satisfy their working environment project requirements. The TL4 has a three stage telescopic outer tube that is designed for a narrow-top, wide-bottom square appearance.

General Features

Maximum load	800N in push
Maximum speed at full load	33mm/s (with 800N in a push condition)
Minimum installation dimension	590 / 560 (M) / 520 (S) mm
Stroke	650 / 660 (M, S)mm
Dimension of outer tube (L*W)	70*70mm
Color	Black, white, grey, or special grey
Three stage outer tube with square appearance	
With narrow top and wide bottom configuration	

Drawing

Standard Dimensions
(mm)

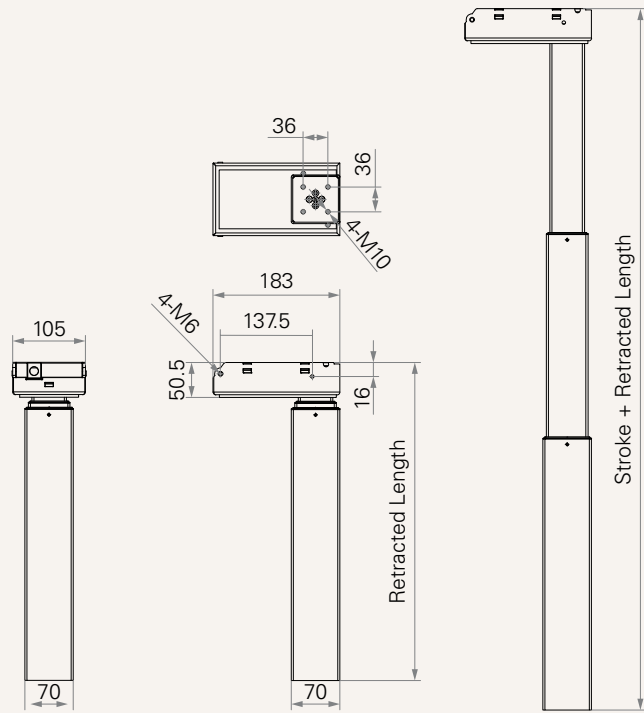

Load and Speed

CODE	Load (N)	Self Locking Force (N)	Typical Current (A)		Typical Speed (mm/s)	
	Push		No Load 32V DC	With Load 24V DC	No Load 32V DC	With Load 24V DC
Motor Speed (5200RPM)						
C	800	800	2.8	6.0	58.0	33.0

Note

- 1 This self-locking force level is reached only when a short circuit is applied on the terminals of the motor. All the TiMOTION control boxes have this feature built-in.
- 2 Parameters above are from tested average, please refer to approval drawing for final value.

Performance Data (24V DC Motor)

Motor Speed (5200RPM)

Speed vs. Load

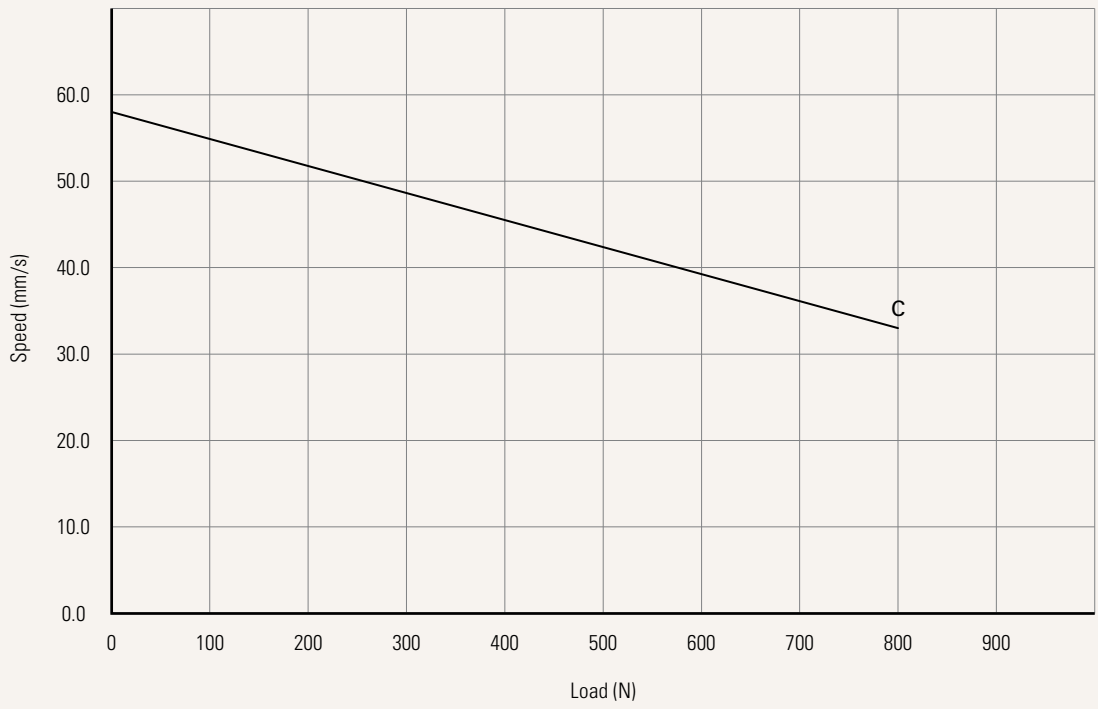

Current vs. Load

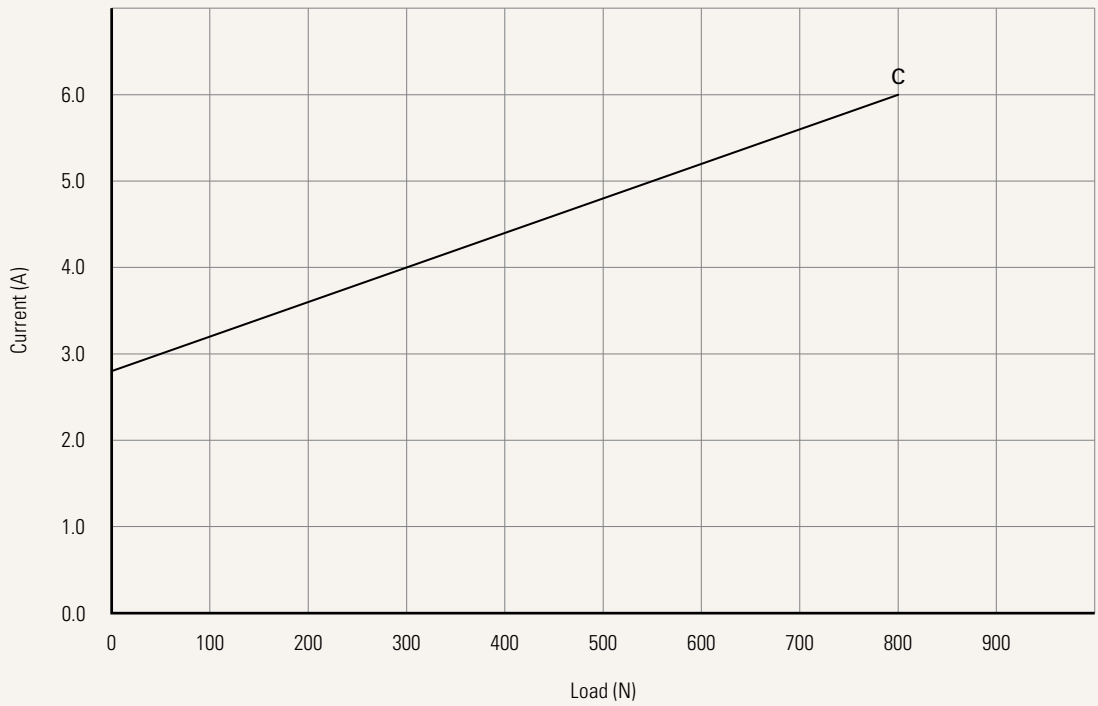

Note

1 The performance data in the curve charts shows theoretical value.

Appearance of Tubes	B = With wiper fixing holes at sides	C = Without wiper fixing holes at sides	
Voltage	2 = 24V DC		
Load and Speed	See page 2		
Stroke & Retracted Length (mm)	See page 5		
Color	1 = Black, RAL 9005, Black wiper 2 = Grey, RAL 9006, Black wiper 3 = White, RAL 9016, Black wiper 4 = Special grey, RAL 9022, Black wiper	6 = Grey, RAL 9006, Grey wiper 7 = White, RAL 9016, White wiper 8 = Special grey, RAL 9022, Grey wiper B = Matte black, RAL 7021, Black wiper	
Motor Housing Step	0 = With	1 = Without	
Output Signals	2 = Hall sensor*2		
Connector See page 5	1 = DIN 6P, 90° plug E = Molex 8P, plug, standard		
Cable Length (mm)	1 = Straight, 500	4 = Straight, 1500	
Welding Part See page 5	0 = Without L = Left	R = Right F = Front	B = Back

Note

¹ The TL is designed especially for push applications, not suitable for pull applications.

Stroke & Retracted Length (mm)

A. Stroke & Retracted Length (mm)

Foot Assembly	Stroke & Retracted Length		
	Standard	M	S
Standard	650 / 590	660 / 560	660 / 520
With Shoes	650 / 610	660 / 580	-

Note

1 Only specific TEK could be with the shoes, please refer to TEK speccode

Foot Assembly

Standard



With shoes

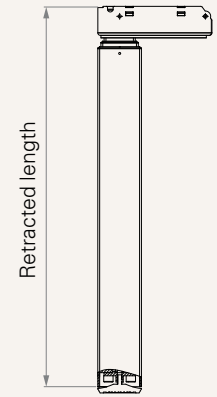

Connector

1 = DIN 6P, 90° plug

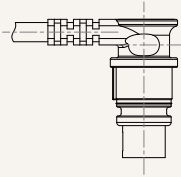

E = Molex 8P, plug, standard

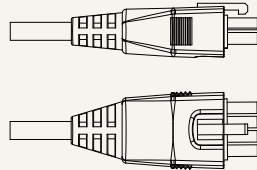

Welding Part

Direction

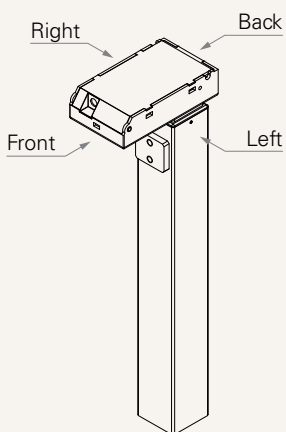

Terms of Use

The user is responsible for determining the suitability of TiMOTION products for a specific application. TiMOTION products are subject to change without prior notice.