

# TA7

series

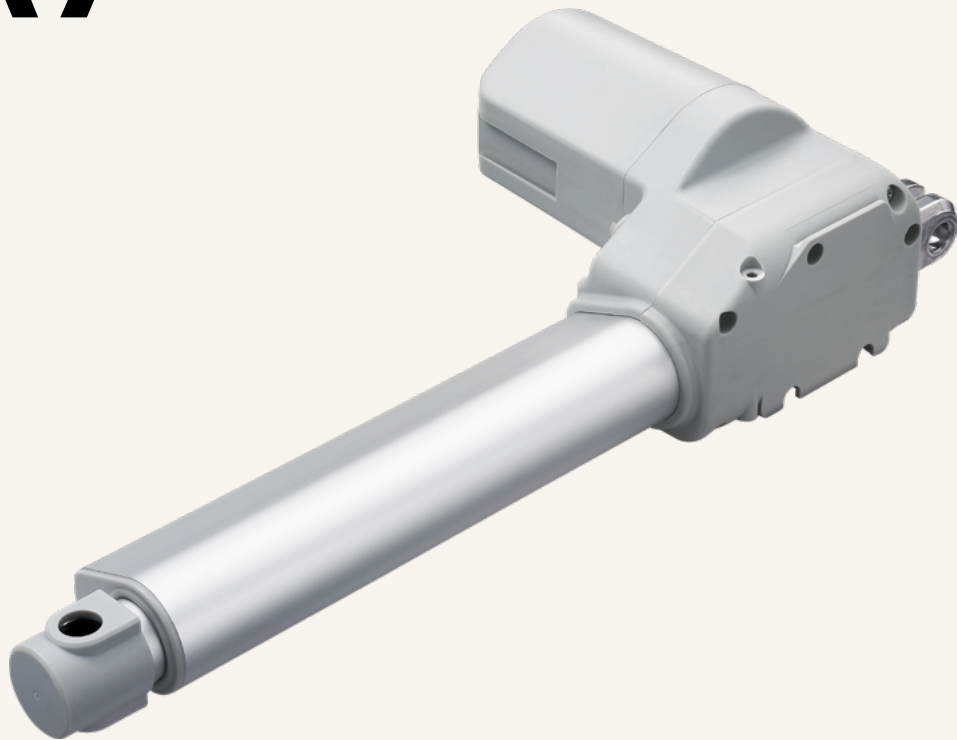

## Product Segments

### • Care Motion

TiMOTION's TA7 is one of the classic linear actuators for medical applications. The TA7's design is compliant with key standards such as IEC60601-1 and ES60601-1. In addition, the TA7 linear actuator is available with an optional IP54, IP66 or IP66W rating. Medical equipment is typical application for the TA7 series linear actuator.

#### General Features

Voltage of motor	12, 24, or 36V DC
Maximum load	10,000N in push
Maximum load	4,000N in pull
Maximum speed at full load	23.4mm/s (with 1,000N in a push or pull condition)
Stroke	25~1000mm
Minimum installation dimension	≥ Stroke + 171mm
Color	Black or grey
IP rating	Up to IP66W
Certificate	IEC60601-1, ES60601-1, IEC60601-1-2 , EMC
Operational temperature range	+5°C~+45°C
Options	Safety nut, Hall / Reed sensor(s)

**Drawing**

Standard Dimensions  
(mm)

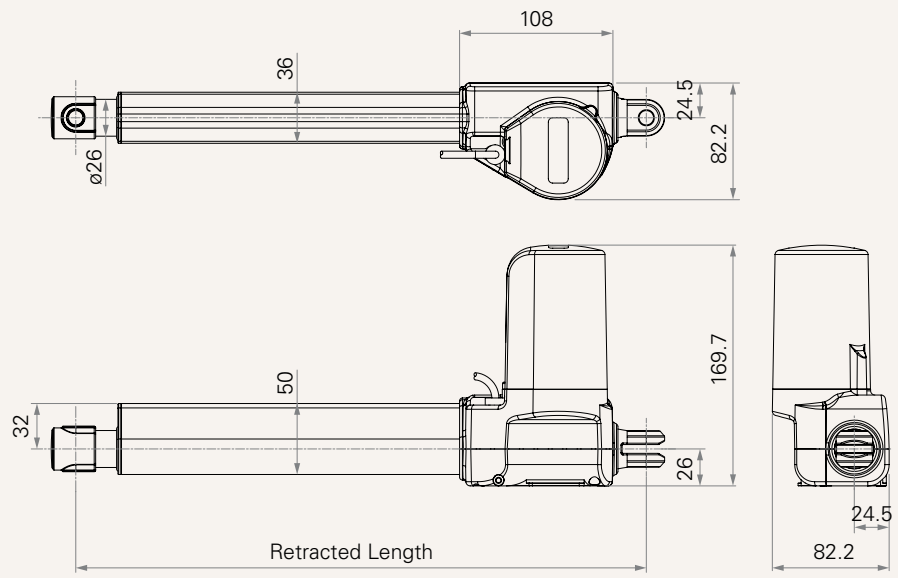

## Load and Speed

CODE	Load (N)		Self Locking Force (N)	Typical Current with Load (A)		Typical Speed (mm/s)	
	Push	Pull		No Load 32V DC	With Load 24V DC	No Load 32V DC	With Load 24V DC
<b>Motor Speed (2600RPM)</b>							
<b>C</b>	5000	4000	5000	0.8	3.5	8.0	4.1
<b>D</b>	6000	4000	6000	0.8	3.5	6.0	3.1
<b>F</b>	2500	2500	2500	0.8	3.2	15.9	8.3
<b>G</b>	2000	2000	2000	0.8	2.8	21.4	12.1
<b>H</b>	1000	1000	1000	0.8	2.1	32.1	19.1
<b>J</b>	3500	3500	3500	0.8	3.6	11.9	6.0
<b>K</b>	8000	4000	8000	0.8	4.0	5.4	2.7
<b>Motor Speed (3400RPM)</b>							
<b>L</b>	6000	4000	6000	1.0	4.2	7.3	4.1
<b>N</b>	2500	2500	2500	1.0	4.1	19.4	11.1
<b>O</b>	2000	2000	2000	1.0	4.0	26.1	14.9
<b>P</b>	1000	1000	1000	1.0	3.0	39.0	23.4
<b>Q</b>	3500	3500	3500	1.0	4.6	14.5	7.9
<b>R</b>	8000	4000	8000	1.0	5.0	6.6	3.5
<b>T</b>	5000	4000	5000	1.0	4.2	9.8	5.4
<b>Motor Speed (3800RPM)</b>							
<b>Y</b>	8000	4000	8000	1.2	5.3	7.7	4.4
<b>B</b>	10000	4000	10000	1.2	5.3	5.7	3.2
<b>U</b>	5000	4000	5000	1.2	4.7	11.3	6.6
<b>W</b>	2500	2500	2500	1.2	4.6	23.0	13.4
<b>Z</b>	3500	3500	3500	1.2	5.3	16.8	9.8

## Note

- 1 Please refer to the approved drawing for the final authentic value.
- 2 This self-locking force level is reached only when a short circuit is applied on the terminals of the motor. All the TiMOTION control boxes have this feature built-in.
- 3 The current & speed in table are tested with 24V DC motor. With a 12V DC motor, the current is approximately twice the current measured in 24V DC. With a 36V DC motor, the current is approximately two-thirds the current measured in 24V DC. Speed will be similar for all the voltages.
- 4 The current & speed in table are tested when the actuator is extending under push load.
- 5 The current & speed in table and diagram are tested with TiMOTION control boxes, and there will be around 10% tolerance depending on different models of the control box. (Under no load condition, the voltage is around 32V DC. At rated load, the voltage output will be around 24V DC)
- 6 Standard stroke: Min.  $\geq$  25mm, Max. please refer to below table.

CODE	Load (N)	Max Stroke (mm)
<b>K, R, Y, B</b>	$\geq$ 8000	450
<b>D, L</b>	$=$ 6000	600
<b>Others</b>	$<$ 6000	1000

**Performance Data (24V DC Motor)**

Motor Speed (2600RPM)

Speed vs. Thrust

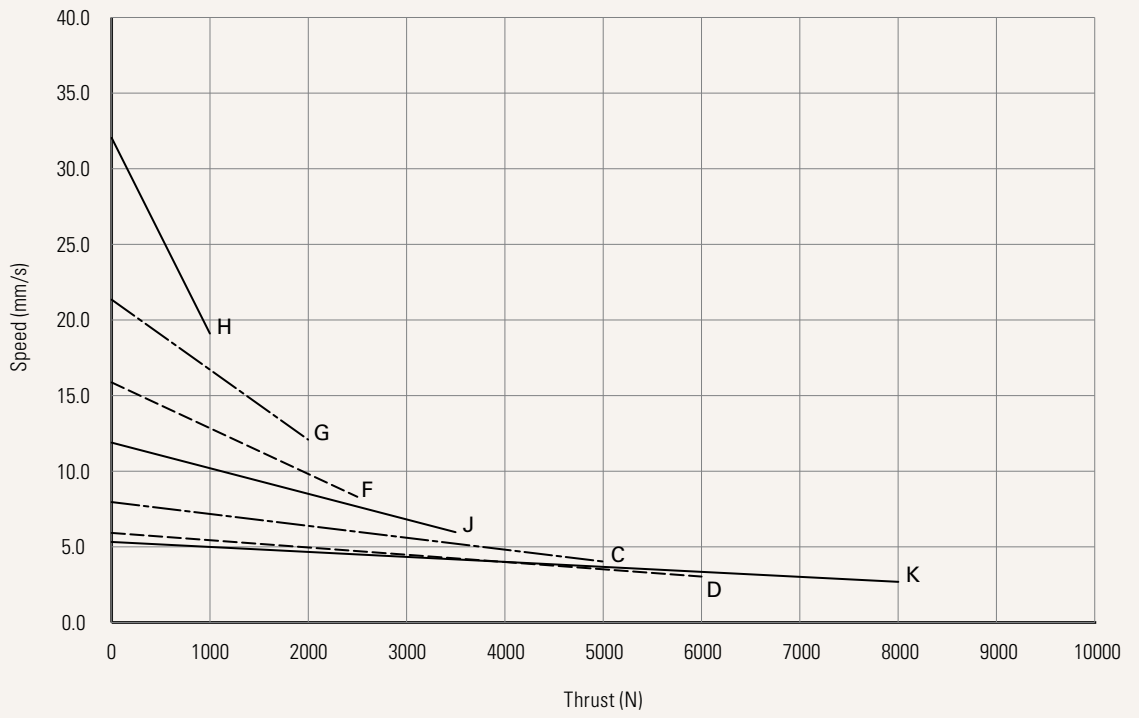

Current vs. Thrust

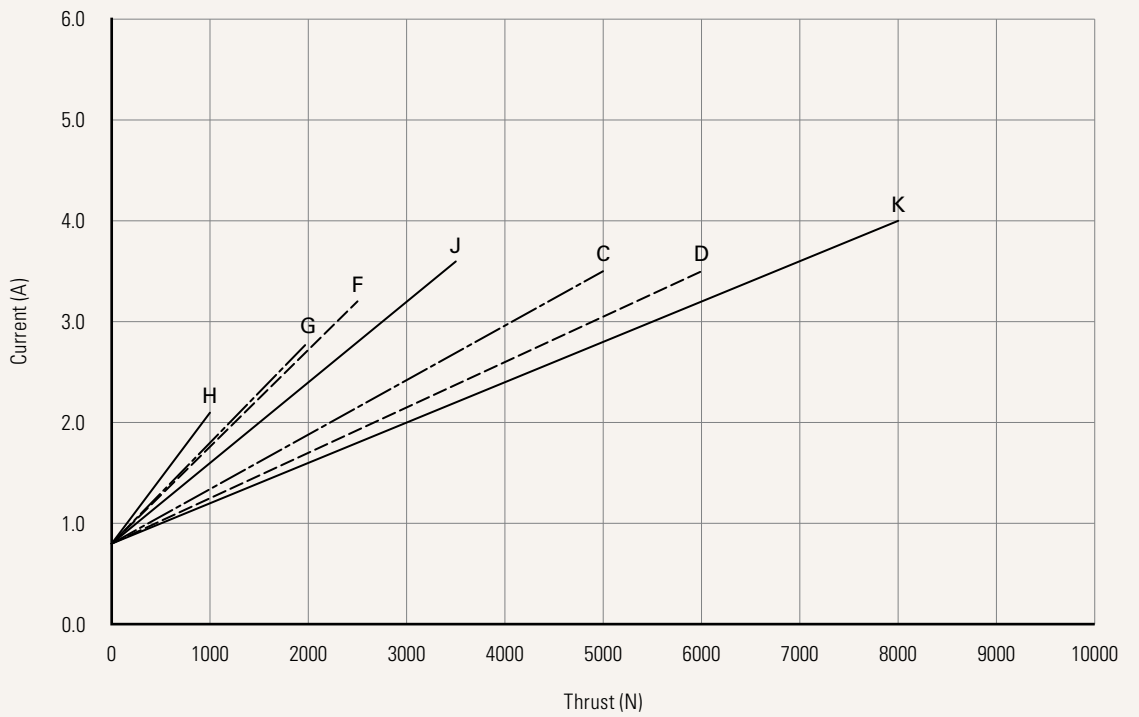

**Performance Data (24V DC Motor)**

Motor Speed (3400RPM)

Speed vs. Thrust

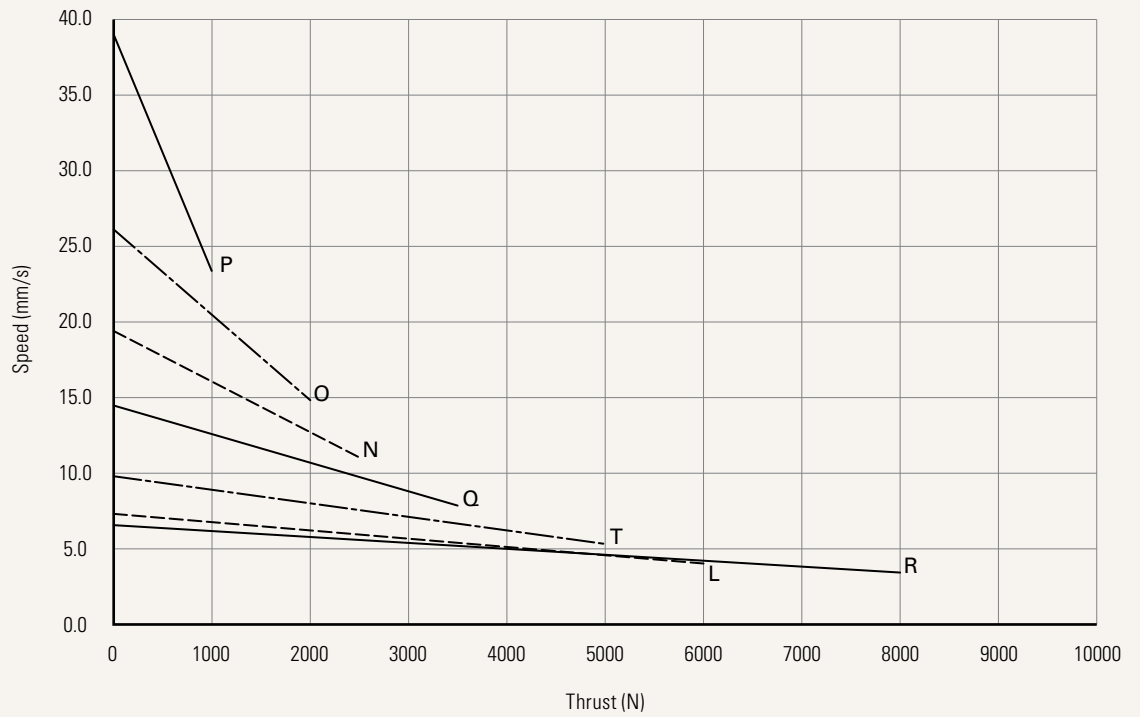

Current vs. Thrust

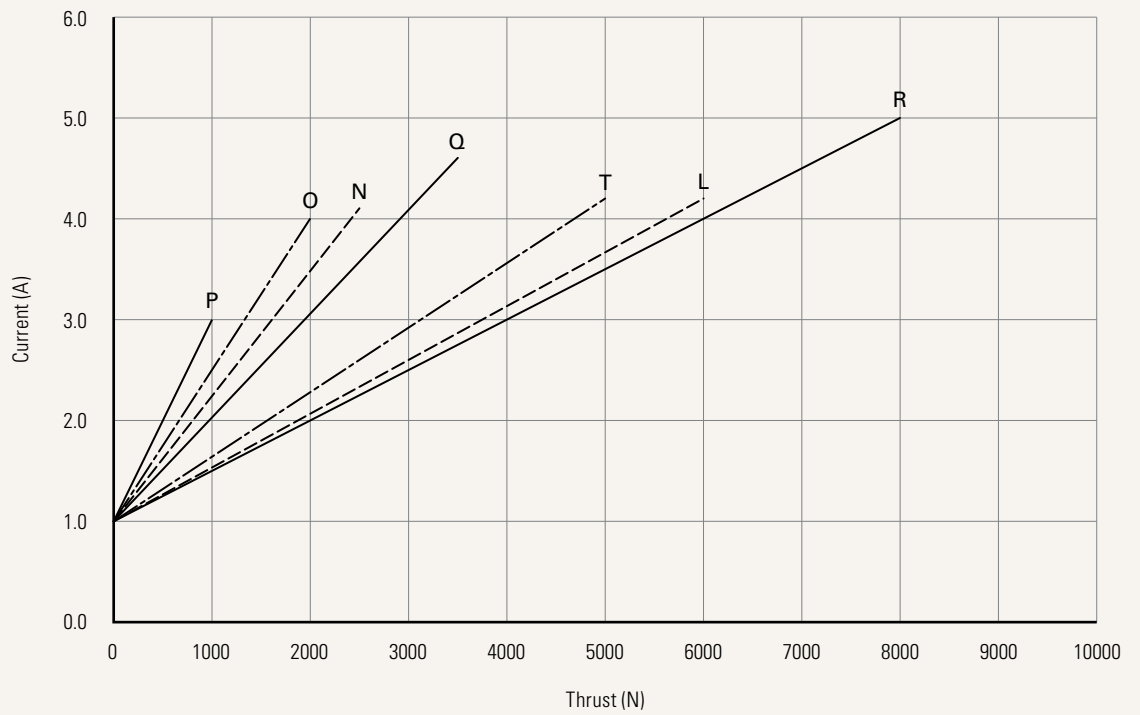

**Performance Data (24V DC Motor)**

Motor Speed (3800RPM)

Speed vs. Thrust

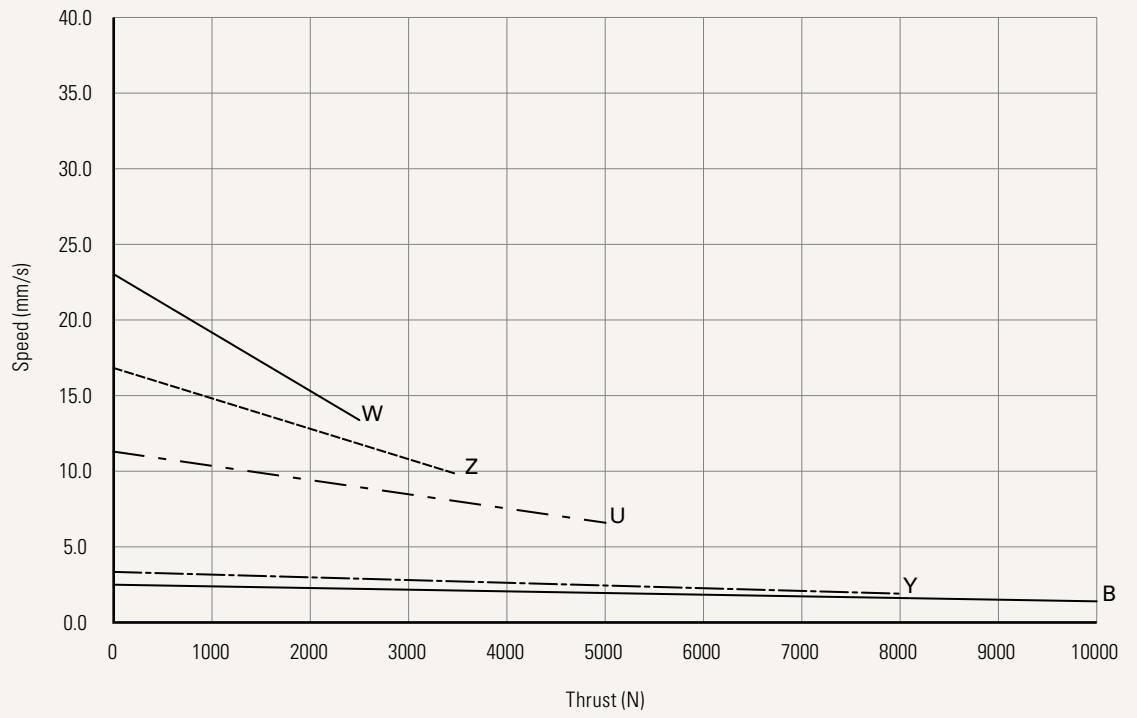

Current vs. Thrust

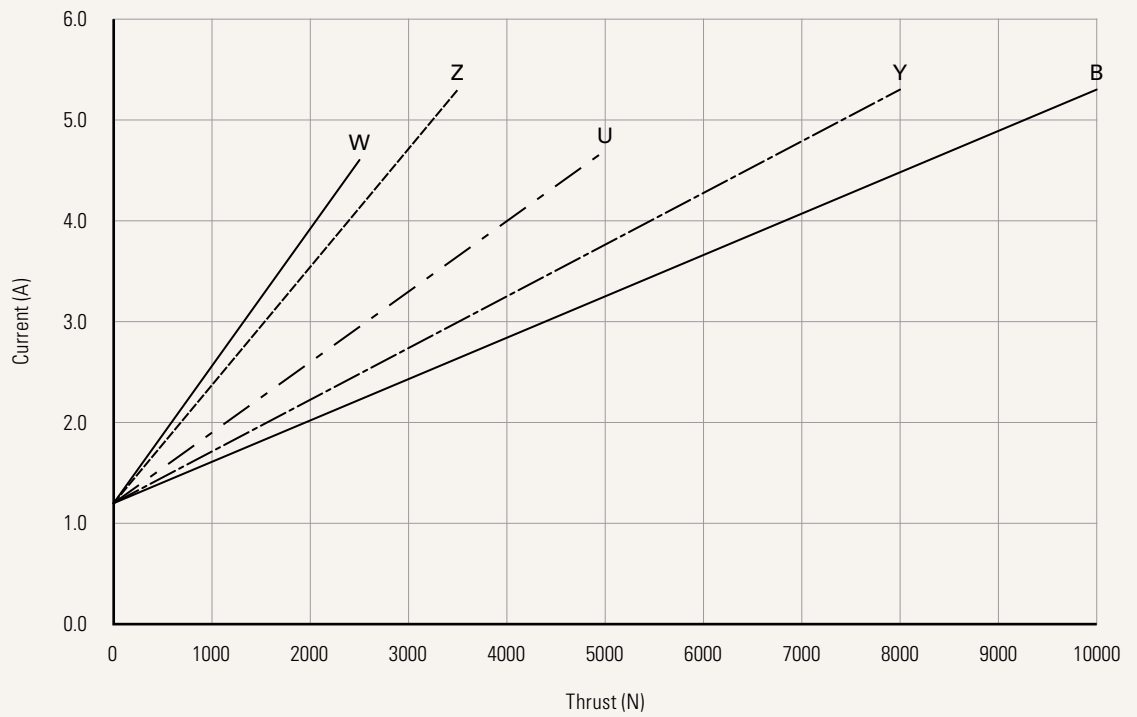

<b>Voltage</b>	1 = 12V DC	2 = 24V DC	3 = 36V DC
<b>Load and Speed</b>	<a href="#">See page 2</a>		
<b>Stroke (mm)</b>	<a href="#">See page 2</a>		
<b>Retracted Length (mm)</b>	<a href="#">See page 7</a>		
<b>Rear Attachment (mm)</b> <a href="#">See page 9</a>	2 = Aluminum casting, U clevis, slot 6.2, depth 17.0, hole 10.2 3 = Aluminum casting, U clevis, slot 6.2, depth 17.0, hole 12.2 4 = Aluminum casting, U clevis, slot 8.2, depth 17.0, hole 10.2 5 = Aluminum casting, U clevis, slot 8.2, depth 17.0, hole 12.2 C = Aluminum casting, U clevis, slot 8.2, depth 17.0, hole 10.2, T-bush		
<b>Front Attachment (mm)</b> <a href="#">See page 9-10</a>	1 = Punched hole on inner tube + plastic cap, without slot, hole 10.2, with plastic bushing 2 = Punched hole on inner tube + plastic cap, without slot, hole 12.2 3 = Plastic, U clevis, slot 8.2, depth 20.2, hole 10.2, for load push < 4000N & pull < 2500N 4 = Plastic, U clevis, slot 8.2, depth 20.2, hole 12.2, for load push < 4000N & pull < 2500N 5 = Punched hole on inner tube, without slot, hole 10.2, with plastic bushing	6 = Punched hole on inner tube, without slot, hole 12.2 7 = Aluminum casting, U clevis, slot 6.2, depth 17.0, hole 10.2 8 = Aluminum casting, U clevis, slot 6.2, depth 17.0, hole 12.2 9 = Aluminum casting, U clevis, slot 6.2, depth 17.0, hole 10.2, with plastic T-bushing J = Aluminum casting, without slot, hole 10.2, for dental chair	
<b>Direction of Rear Attachment (Counterclockwise)</b> <a href="#">See page 10</a>	1 = 0°	3 = 90°	
<b>Color</b>	1 = Black	2 = Grey (Pantone 428C)	
<b>IP Rating</b>	1 = Without	2 = IP54	3 = IP66 5 = IP66W
<b>Special Functions for Spindle Sub-Assembly</b>	0 = Without 1 = Safety nut	2 = Standard push only 3 = Standard push only + safety nut	
<b>Functions for Limit Switches</b> <a href="#">See page 10</a>	1 = Two switches at full retracted / extended positions to cut current 2 = Two switches at full retracted / extended positions to cut current + third one in between to send signal 3 = Two switches at full retracted / extended positions to send signal 4 = Two switches at full retracted / extended positions to send signal + third one in between to send signal 5 = Two switches at full retracted / extended positions to send signal (Operate with control box: TC1, TC8, TC10, TC14)		
<b>Output Signals</b>	0 = Without	1 = Hall sensor * 1	2 = Hall sensor * 2 3 = Reed Sensor
<b>Connector</b> <a href="#">See page 11</a>	1 = DIN 6P, 90° plug 2 = Tinned leads 4 = Big 01P, plug C = Y cable (For direct cut system, water proof, anti pull) D = Extension cable, not preset on motor cover (Cable legth 120mm) R = Extension cable, preset on motor cover (Cable legth 50mm)	E = Molex 8P, plug F = DIN 6P, 180° plug, for TEC extension cable standard option M = DIN 4P, dental chair plug (40510-143, standard) N = DIN 4P, dental chair plug (40510-040) G = Audio plug	
<b>Cable Length</b>	0 = Straight, 100mm 1 = Straight, 500mm 2 = Straight, 750mm	3 = Straight, 1000mm 4 = Straight, 1250mm 5 = Straight, 1500mm	6 = Straight, 2000mm 7 = Curly, 200mm 8 = Curly, 400mm B-H = For direct cut system <a href="#">See page 11</a>

## Retracted Length (mm)

1. Calculate  $A+B+C = Y$
2. Retracted length needs to  $\geq$  Stroke + Y

### A. Front Attachment

#### CODE

<b>1, 2, 5, 6</b>	+171
<b>3, 4</b>	+192
<b>7, 8, 9</b>	+183
<b>J</b>	+172

### B. Load V.S. Stroke

Stroke (mm)	Load (N)			
	< 6000	= 6000	= 8000	= 10000
<b>25~150</b>	-	-	-	+5
<b>151~200</b>	-	-	+5	+10
<b>201~250</b>	-	+5	+10	+15
<b>251~300</b>	-	+10	+15	+20
<b>301~350</b>	+5	+15	+20	+25
<b>351~400</b>	+10	+20	+25	+30
<b>401~450</b>	+15	+25	+30	+35
<b>451~500</b>	+20	+30	-	-
<b>501~550</b>	+25	+35	-	-
<b>551~600</b>	+30	+40	-	-
<b>601~650</b>	+35	-	-	-
<b>651~700</b>	+40	-	-	-
<b>701~750</b>	+45	-	-	-
<b>751~800</b>	+50	-	-	-
<b>801~850</b>	+55	-	-	-
<b>851~900</b>	+60	-	-	-
<b>901~950</b>	+65	-	-	-
<b>951~1000</b>	+70	-	-	-

### C. Front Attachment V.S Special Function

Front Attachment	Spindle Function	
	0, 1	2, 3
<b>Load (N) &lt; 6000</b>		
<b>1, 2, 5, 6</b>	-	+5
<b>3, 4</b>	-	-
<b>7, 8, 9</b>	-	-
<b>J</b>	-	+5
<b>Load (N) <math>\geq</math> 6000</b>		
<b>1, 2, 5, 6</b>	-	+8
<b>3, 4</b>	-	-
<b>7, 8, 9</b>	-	+3
<b>J</b>	-	+8



## Rear Attachment (mm)

2 = Aluminum casting, U clevis, slot 6.2, depth 17.0, hole 10.2

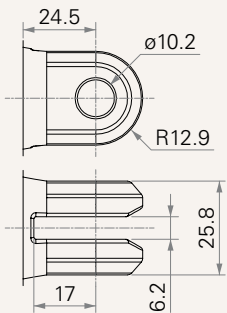

3 = Aluminum casting, U clevis, slot 6.2, depth 17.0, hole 12.2

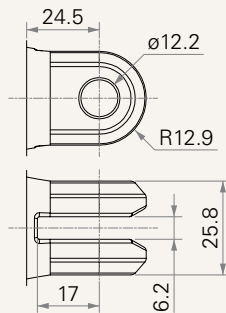

4 = Aluminum casting, U clevis, slot 8.2, depth 17.0, hole 10.2

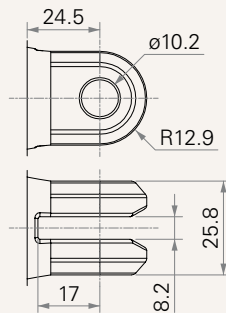

5 = Aluminum casting, U clevis, slot 8.2, depth 17.0, hole 12.2

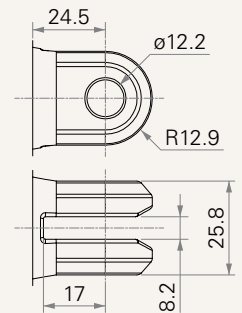

C = Aluminum casting, U clevis, slot 8.2, depth 17.0, hole 10.2, T-bush

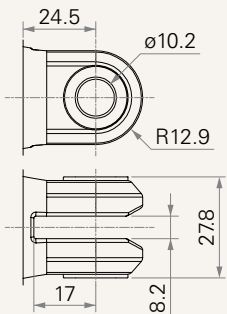

## Front Attachment (mm)

1 = Punched hole on inner tube + plastic cap, without slot, hole 10.2, with plastic bushing

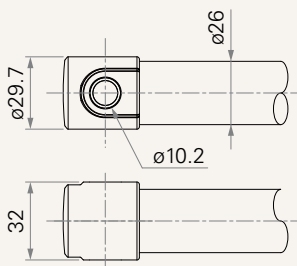

2 = Punched hole on inner tube + plastic cap, without slot, hole 12.2

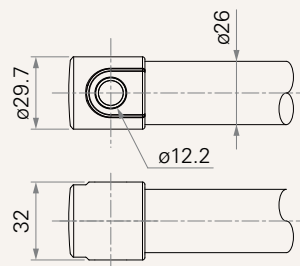

3 = Plastic, U clevis, slot 8.2, depth 20.2, hole 10.2, for load push < 4000N & pull < 2500N

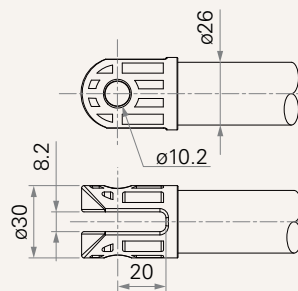

4 = Plastic, U clevis, slot 8.2, depth 20.2, hole 12.2, for load push < 4000N & pull < 2500N

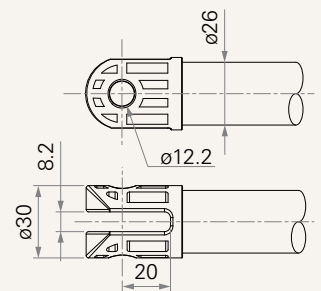

5 = Punched hole on inner tube, without slot, hole 10.2, with plastic bushing

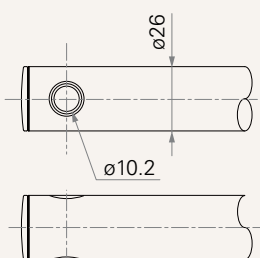

6 = Punched hole on inner tube, without slot, hole 12.2

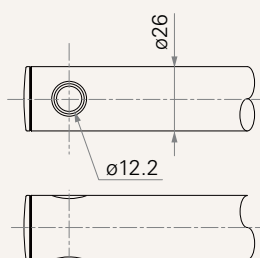

7 = Aluminum casting, U clevis, slot 6.2, depth 17.0, hole 10.2

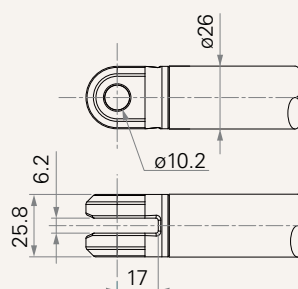

8 = Aluminum casting, U clevis, slot 6.2, depth 17.0, hole 12.2

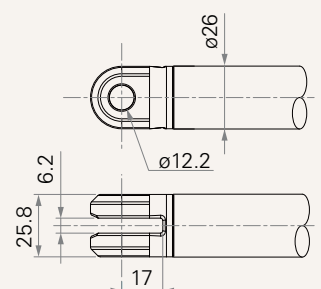

## Front Attachment (mm)

9 = Aluminum casting, U clevis, slot 6.2, depth 17.0, hole 10.2, with plastic T-bushing

J = Aluminum casting, without slot, hole 10.2, for dental chair

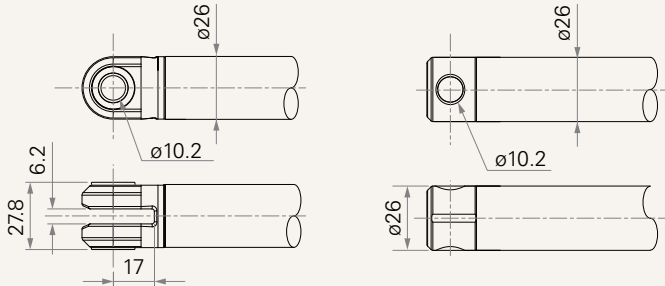

## Direction of Rear Attachment (Counterclockwise)

1 = 0°

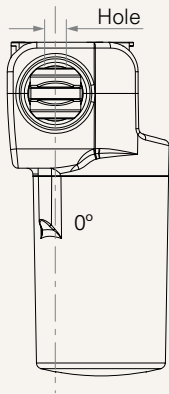

3 = 90°

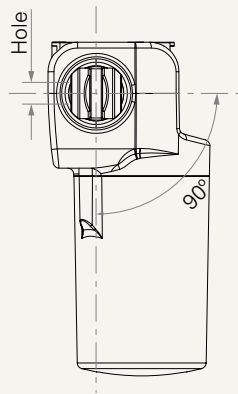

## Functions for Limit Switches

### Wire Definitions

CODE	Pin					
	● 1 (Green)	● 2 (Red)	○ 3 (White)	● 4 (Black)	● 5 (Yellow)	● 6 (Blue)
1	extend (VDC+)	N/A	N/A	N/A	retract (VDC+)	N/A
2	extend (VDC+)	N/A	middle switch pin B	middle switch pin A	retract (VDC+)	N/A
3	extend (VDC+)	common	upper limit switch	N/A	retract (VDC+)	lower limit switch
4	extend (VDC+)	common	upper limit switch	medium limit switch	retract (VDC+)	lower limit switch
5	extend (VDC+)	N/A	upper limit switch	common	retract (VDC+)	lower limit switch

## Connector

1 = DIN 6P, 90° plug

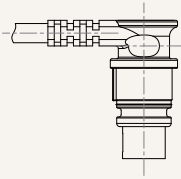

2 = Tinned leads

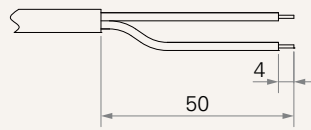

4 = Big 01P, plug

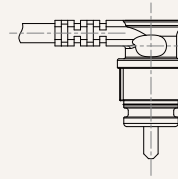

C = Y cable (For direct cut system, water proof, anti pull)

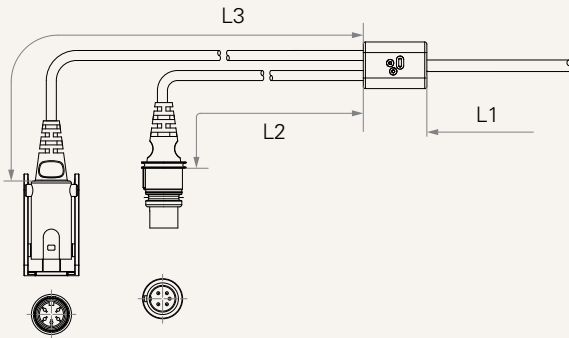

### Cable length for direct cut system (mm)

CODE	L1	L2	L3
B	100	100	100
C	100	1000	400
D	100	2700	500
E	1000	100	100
F	100	600	1000
G	1500	1000	1000
H	100	100	1200

D = Extension cable, not preset on motor cover (Cable length 120mm)

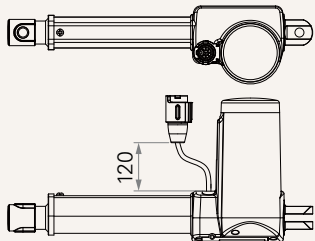

R = Extension cable, preset on motor cover (Cable length 50mm)

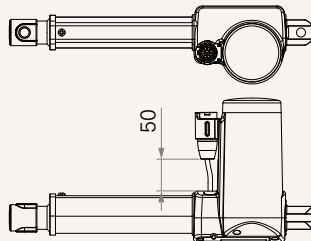

E = Molex 8P, plug

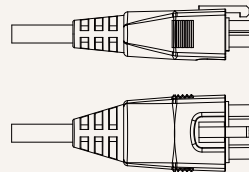

F = DIN 6P, 180° plug, for TEC extension cable standard option

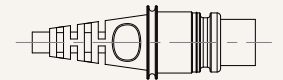

M = DIN 4P, dental chair plug (40510-143, standard)

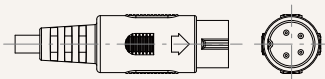

N = DIN 4P, dental chair plug (40510-040)

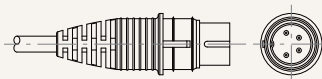

G = Audio plug



## Terms of Use

The user is responsible for determining the suitability of TiMOTION products for a specific application. TiMOTION products are subject to change without prior notice.