

TA26

series



Product Segments

- **Comfort Motion**

TiMOTION's TA26 series electric linear actuator is designed for furniture applications such as recliners or lift chairs. This linear actuator is designed to function as a direct cut system, eliminating the need for a control box, offering a straightforward alternative to complex electric actuation systems.

General Features

Voltage of motor	12V DC or 24V DC
Maximum load	4,000N in push
Maximum load	2,000N in pull
Maximum speed at full load	12.8mm/s (with 2,000N in a push or pull condition)
Minimum installation dimension	≥ Stroke + 120mm
Color	Black
Certificate	UL962
Operational temperature range	+5°C~+45°C
Options	Hall sensor(s)

Drawing

Standard Dimensions
(mm)

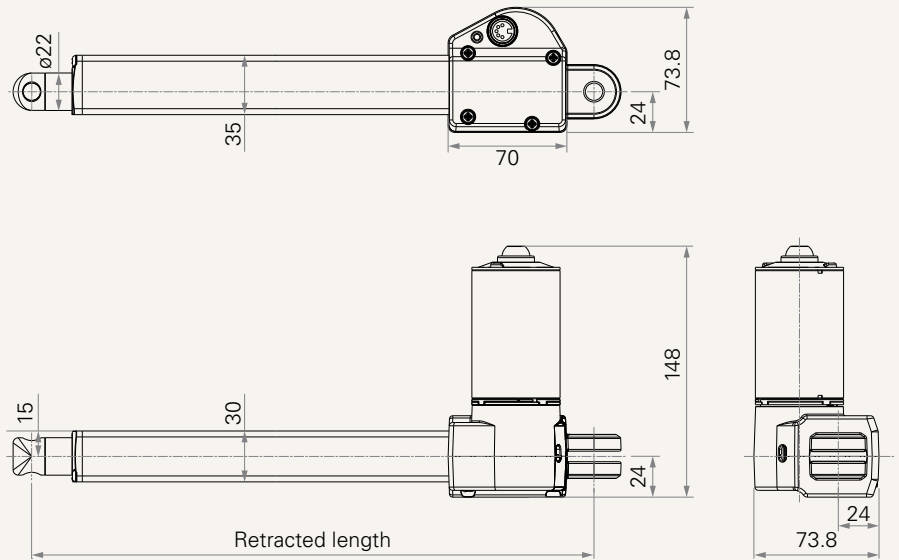

Load and Speed

CODE	Load (N)		Self Locking Force (N)	Typical Current (A)		Typical Speed (mm/s)	
	Push	Pull		No Load 32V DC	With Load 24V DC	No Load 32V DC	With Load 24V DC
Motor Speed (3800RPM, duty cycle 10%)							
A	4000	2000	4000	1.0	5.0	12.0	6.1
B	3000	2000	2500	1.0	4.5	18.0	7.5
C	2000	2000	1500	1.0	4.0	24.0	12.8

Note

- 1 The current & speed in table are tested with 24V DC motor. With a 12V DC motor, the current is approximately twice the current measured in 24V DC; speed will be similar for both voltages.
- 2 This self-locking force level is reached only when a short circuit is applied on the terminals of the motor. All the TiMOTION control boxes have this feature built-in.
- 3 The current & speed in table are tested when the actuator is extending under push load.

Performance Data (24V DC Motor)

Motor Speed (3800RPM)

Speed vs. Load

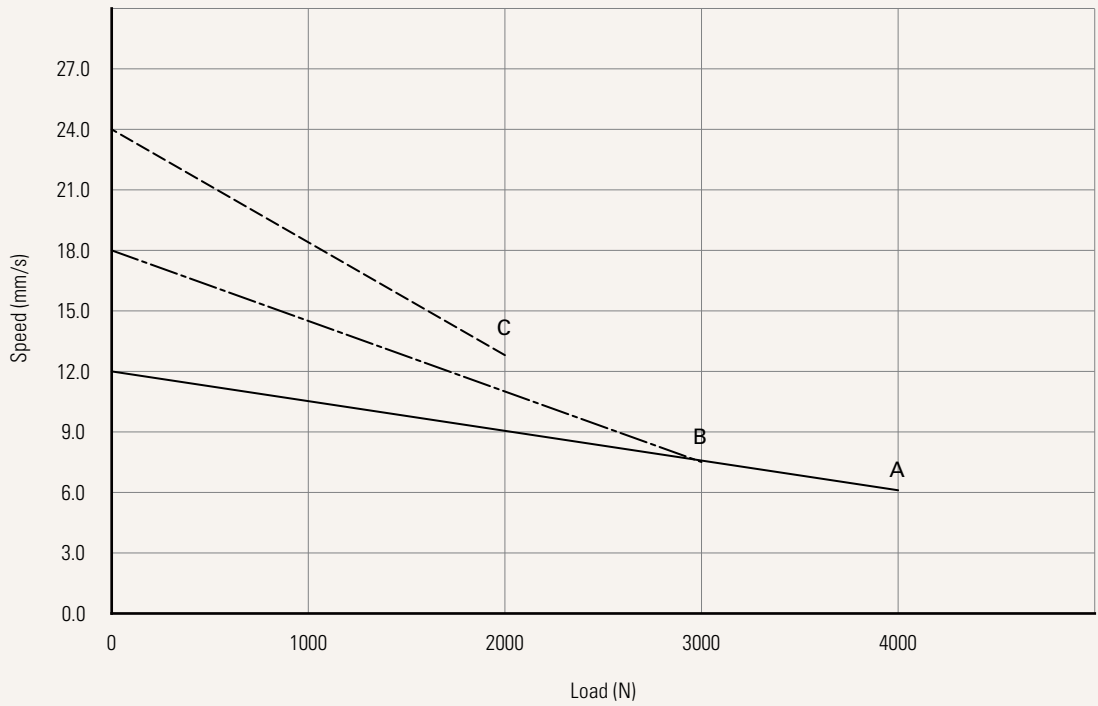

Current vs. Load

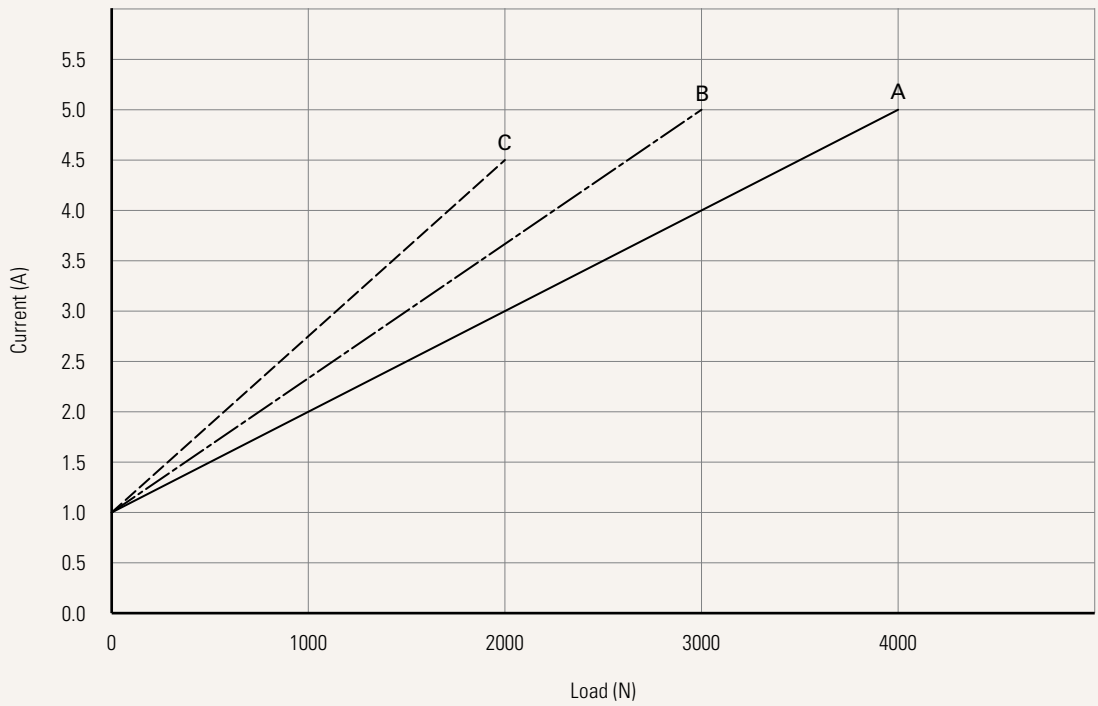

Voltage	1 = 12V	2 = 24V	5 = 24V, PTC	
Load and Speed	See page 2			
Stroke (mm)				
Retracted Length (mm)	See page 5			
Rear Attachment (mm)	1 = Plastic, clevis U, slot 6.2, depth 16.0, hole 10.2			
	See page 5			
Front Attachment (mm)	1 = Plastic, no slot, hole 8.2		4 = Aluminum casting, clevis U, slot 6.2, depth 17.0, hole 10.2	
	2 = Plastic, no slot, hole 10.2			
	3 = Aluminum casting, clevis U, slot 6.2, depth 17.0, hole 8.2			
Special Functions for Spindle Sub-Assembly	0 = Without			
Functions for Limit Switches	1 = Two switches at full retracted / extended positions to cut current			
	2 = Two switches at full retracted/extended positions to cut current + 3rd LS to send signal			
	3 = Two switches at full retracted / extended positions to send signal			
	4 = Two switches at full retracted/extended positions to send signal + 3rd LS to send signal			
Output Signals	0 = Without	1 = Hall sensor * 1	2 = Hall sensor * 2	
Connector	1 = DIN 6P, 90° plug	K = Single motor, direct cut system		
	2 = Tinned leads	L = 1+1, 2 motors direct cut system		
	3 = Small 01P, plug			
Cable Length (mm)	0 = Straight, 100	3 = Straight, 1000	6 = Straight, 2000	K = Direct cut operation with single actuator
	1 = Straight, 500	4 = Straight, 1250	7 = Curly, 200	L = Direct cut operation with two actuators
	2 = Straight, 750	5 = Straight, 1500	8 = Curly, 400	

Note

¹ The TL is designed especially for push applications, not suitable for pull applications.

Retracted Length (mm)

1. Calculate $A+B = Y$
2. Retracted length needs to \geq Stroke + Y

A. Front Attachment

1, 2	+120
3, 4	+150

B. Stroke (mm)

0~150	-
151~200	-
201~250	+5
251~300	+10
301~350	+15
351~400	+20

Note

1 For stroke over 200mm, +5mm for each increment of 50mm stroke .

Rear Attachment (mm)

1 = Plastic, clevis U, slot 6.2, depth 16.0, hole 10.2

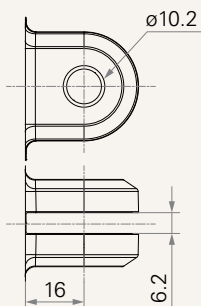

Front Attachment (mm)

1 = Plastic, no slot, hole 8.2

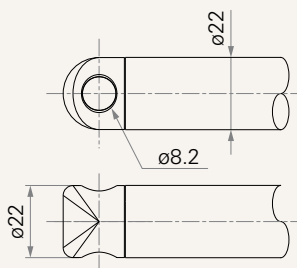

2 = Plastic, no slot, hole 10.2

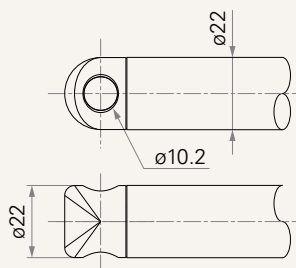

3 = Aluminum casting, clevis U, slot 6.2, depth 17.0, hole 8.2

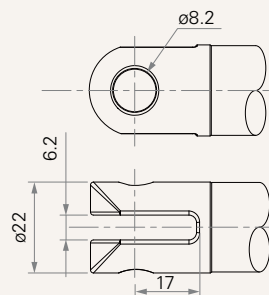

4 = Aluminum casting, clevis U, slot 6.2, depth 17.0, hole 10.2

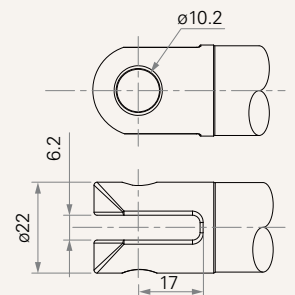

Functions for Limit Switches

Wire Definitions

CODE	Pin					
	● 1 (Green)	● 2 (Red)	○ 3 (White)	● 4 (Black)	● 5 (Yellow)	● 6 (Blue)
1	extend (VDC+)	N/A	N/A	N/A	retract (VDC+)	N/A
2	extend (VDC+)	N/A	middle switch pin B	middle switch pin A	retract (VDC+)	N/A
3	extend (VDC+)	common	upper limit switch	N/A	retract (VDC+)	lower limit switch
4	extend (VDC+)	common	upper limit switch	medium limit switch	retract (VDC+)	lower limit switch

Connector

1 = DIN 6P, 90° plug

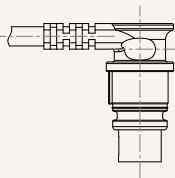

2 = Tinned leads

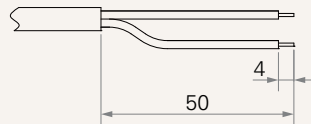

3 = Small 01P, plug

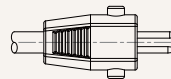

K = Single motor, direct cut system

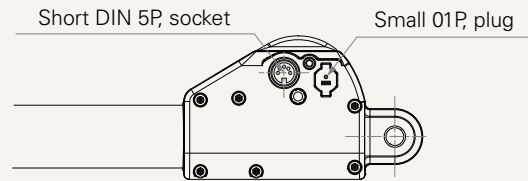

L = 1+1, 2 motors direct cut system

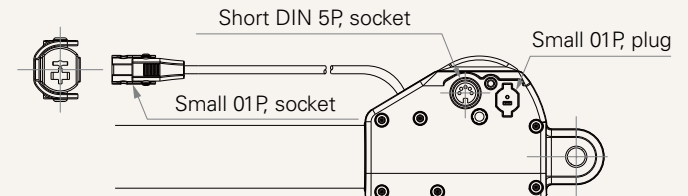

Terms of Use

The user is responsible for determining the suitability of TiMOTION products for a specific application. TiMOTION products are subject to change without prior notice.