

TFH1

series



Product Segments

• Care Motion

Maximum available buttons	12
Protection class	IP54 or IP66
Option	reading light
Flexible gooseneck	
Can be fixed on the head board or side rail	

Drawing

Standard Dimension

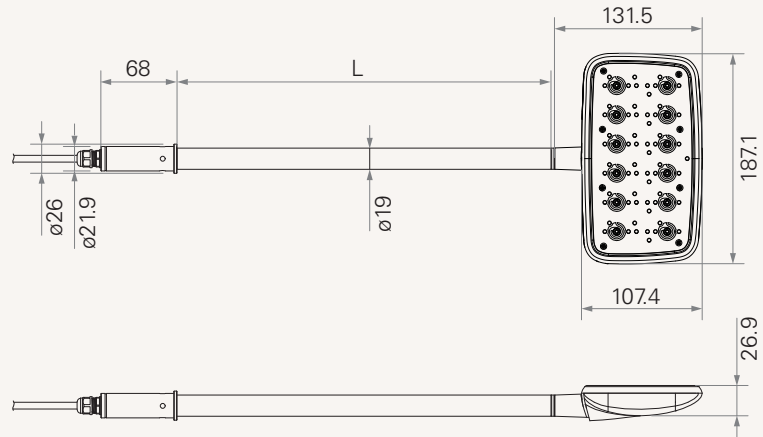

Dimension with Gooseneck and Cable Length

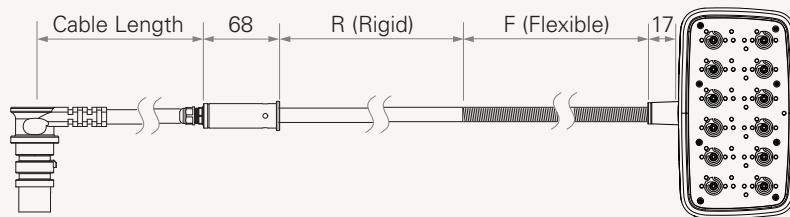

Terms of Use

The user is responsible for determining the suitability of TiMOTION products for a specific application.









Due to continuous development in order to improve our products, TiMOTION products are subject to frequent modifications and changes without prior notice.

TiMOTION reserves the right to discontinue the sale of any products displayed on its website or listed in its catalogue or other written materials drawn up by TiMOTION.

TFH1 Ordering Key

TFH1

Version: 20130820-D

	Reading Light	0 = Without	1 = With		
	Plug	5 = RJ 10pin, 180°, for TC6/TC9/extension cable (standard)			
	Color	2 = Grey (Pantone 428C)			
	IP Protection	1 = Without	2 = IP54	3 = IP66	
	Gooseneck Type	1 = 17mm + 528mm (F) + 371mm (R)	3 = 17mm + 783mm (F) + 96mm (R)		4 = 17mm + 683mm (F) + 196mm (R)
	Mounting Bracket	1 = Standard		A = Customized	
	Key Definition	A = Customized			
	Cable Length	1 = Straight, 1000mm	2 = Straight, 2000mm	3 = Straight, 3000mm	A = Customized